



# Hot Wedge Welder

## User' s Guide for LST800/800D





Please read this manual carefully before using this machine, and retain it for future reference.

LST800/800D geo-membrane welding machine is our new developed products, which can weld geo-membrane of various thicknesses and are applicable for welding of all thermal-fused material such as LDPE, PVC, HDPE, EVA, and PP and so on.

The control of this series of welding machine adopts PID automatic thermostatic control with high control accuracy and low temperature fluctuation; speed control adopts PWM automatic voltage and speed regulation circuit, driven by DC servo motor, with great output torque and the operating is stable. It can maintain a constant speed on the condition of creeping, vertical creeping and variable road load. Also this series of welding machine is stable in performance despite of external temperature and voltage variation.

This series of welding machine is excellent in performance and easy for operating, with high welding speed and good work quality. It is extensively used in engineering projects such as expressways, tunnels, reservoirs, waterproof of construction and so on

### 1. Technical parameters

Voltage (V): 220V or 110V

Frequency (Hz): 50Hz

Power (P): 800W

Welding speed (V): 0.8-6m/min

Heating temperature (T): 0-450°C

Thickness of material to be welded: 0.2mm-1.5mm

Overlap width: 100mm (or 120, 150, 200mm)

Welding width: 12.5mm×2, interior cavity 12mm

Seam strength: ≥85% base material (tensile resistant in shear direction), complete machine

Dimensions: L32 x W15cm x H22cm

Net Weight: 4.8kg, Gross Weight: 8.5kg

Insulation class: class II

## 2. Precautions

- 1). For correct operation, please carefully read this instruction.
- 2). Use with grounded 3-cords mains cable and socket (socket with 10A capacity. On the corresponding welder, phase L connected to live wire, N to zero line, phase  $\perp$  to grounded protection line), plug will not be modified without prior permission.
- 3). For good welding quality, please assign specified personnel for operation.
- 4). Pressure roller will not engage on free running.
- 5). Do not operate when it is exposed to water to prevent inferior quality.
- 6). The machine has been regulated before leaving factory. Please do not adjust it at will.
- 7). Circuit board in control box is electrified. Do not remove it without prior notice to authorized personnel.
- 8). Preheat for 30 minutes before start up if machine has been long unused or exposed to moisture.
- 9). Modifications may be made for continuous improvement, without prior notice.

## 3. Main Components:



Fig.1



Fig. 2

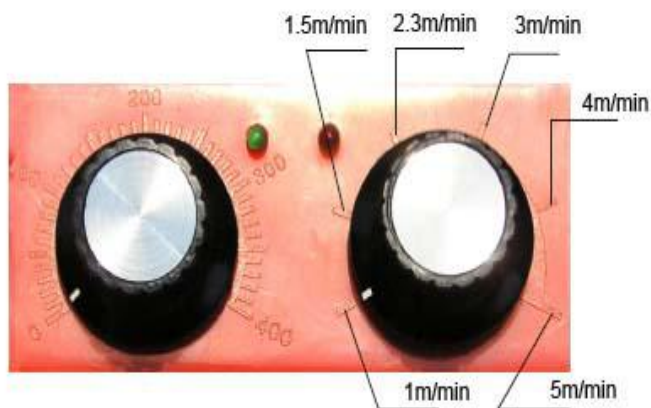

Fig. 3

#### 4. Operation principle

Motor drives upper and lower pressure rollers to rotate through reduction gearbox and chain. Slide carriages drive the hot wedge and insert it between the two base materials, at the same time lever presses pressure rollers and engages the two fused base materials.

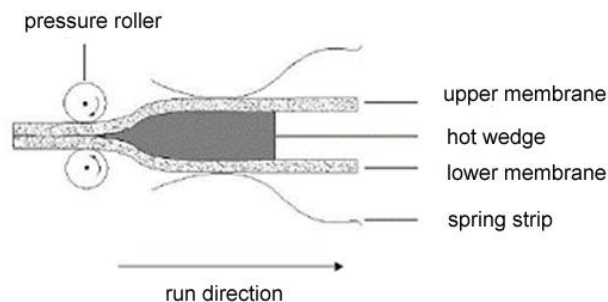

Fig.4

## 5. Operating regulations

As welding quality is direct related to speed and temperature setting during operating, so welding machine must be specified personnel operated to reach excellent quality and high efficiency.

1). Use with grounded 3-cord mains cable and 3-hole socket with capacity not less than 10A (socket corresponds with welder plug, phase L connected to live wire, N to zero line, phase  $\perp$  to grounded protection line), confirm that external lines have been well connected. Check that power is on off state and regulate temperature control potentiometer and speed control potentiometer to 0 position, press lever handle down to disengage pressure roller, then insert the plug.

2). Turn on the power and select certain temperature and speed, take several narrow materials for try welding. Temperature selection may be different for the same material at different ambient temperature and material thickness. To determine the best welding effect, adjust the speed to approximately 2m/min, and then fine increase it from low to high temperature (approximately 250°C-350°C).

3). Judge on welding temperature: for transparent PE material, judge by direct observing, speed and temperature will be appropriate if welding mark is flat and in transparent glass form; temperature will be too high and speed be too slow if mark is heavy broken; temperature will be low and speed be fast if mark is not transparent and with white. For opaque material, observe if there is obvious welding mark, also tensile test can be made after complete cooling.

4). flatly and straightly trim the weld edges and frontage faced, with lower left and upper right

overlapped. The overlap width is 100mm.

5). After temperature and speed have been determined, insert material to be welded between the two pressure rollers, make machine body parallel with edges of base materials and engage press lever handle for proper motion. Generally, only observation of deviation between welding mark and base materials is needed for operator, and timely make correction on small degree.

6). When welding will be ended, timely press lever handle to disengage upper and lower pressure roller to prevent rubber wheel damage for long duration.

7). Excessive temperature high and low may occur because of thermal inertia. On this condition, temperature deviation may be compensated by speed regulation on a small degree.

8). A "T" shape overlap is formed between welded material and another material. Welding method is shown as fig.5, tightly butt the overlap head of hot wedge against weld mark, and beveling cut length is approximately 100mm.

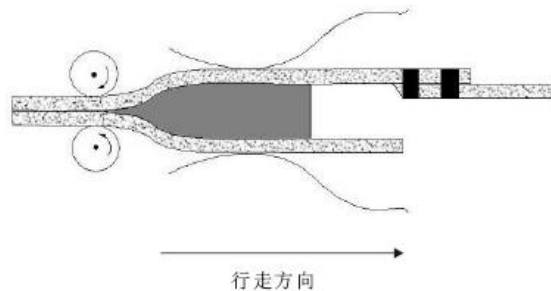

Fig.5 "T" shape welding diagram

## 6. Replacement of components

### 1). Replacement of hot wedge assembly

Remove the front end covering, remove the 4-M4 screws and tapping screw, remove a half housing, release 4-M3 screws, remove the 2-M5 screws that connect heating support and slide carriage, remove hot wedge and replace with a new one, and reassemble the complete machine (shown as fig.6). Note: conform to color on wiring.

(Refer to fig.10 and text information)

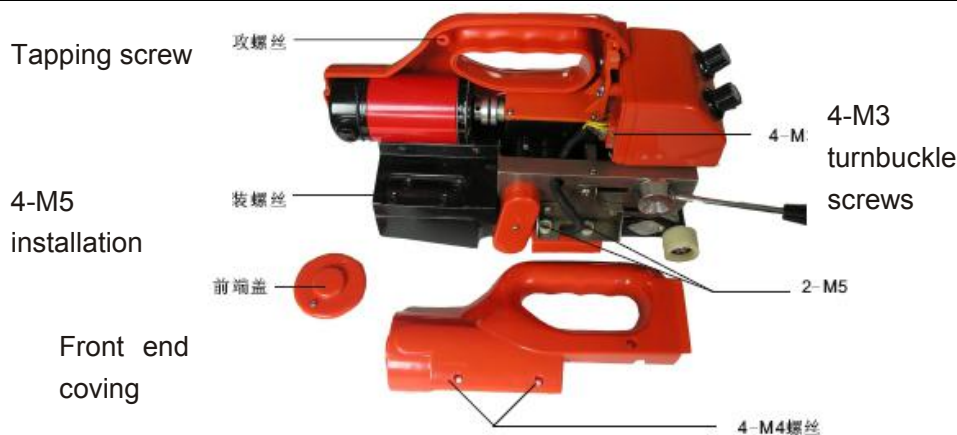

Fig.6

4-M4 screws

### 2). Replacement of control box

Remove all screws on plastic housing, remove housing by removing front end covering, screw off the 4-M3 screws that connect control box to rear base and pull out control box. Loosen the 8-M3 turn buckle screws on the two sides, remove the control box and replace a new one, reassemble the complete machine (shown as fig.7). Note: conform to color on wiring. (Refer to fig.10 and text information)



Fig.7

### 3). Replacement of motor

Remove all screws on housing, remove front end covering to remove housing, remove the 4-M5 installation screws on the support, remove the main chain guard and separate the upper and lower support. Remove the covering on the bottom of upper support and weld connection between motor and fuse holder, screw off the 2-M5 installation screws of the motor, take off motor and replace a new one.

Weld back the removed wires and reassemble on the opposite sequence (Note: keep upper and lower pressure roller is parallel during assembling.).

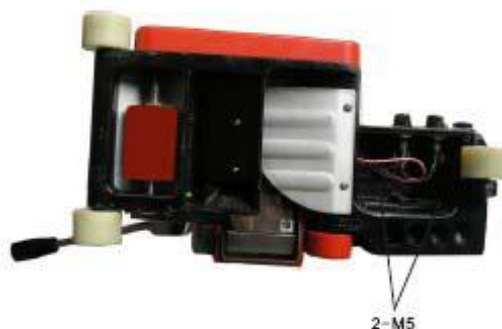

Fig. 8

#### 4) Replacing of upper and lower pressure roller

Remove the chain guard, take off the forcing off screws on the two chain wheels and then remove chain wheel and chain. For upper rubber wheel, it can be removed if the two screws on bearing housing that on both sides of press plate are removed. For lower rubber wheel, it can be removed if the bearing on one side of chain wheel. Reassemble them in the same method.

## 7. Control schematic diagram and motor wiring diagram (Fig.9 &



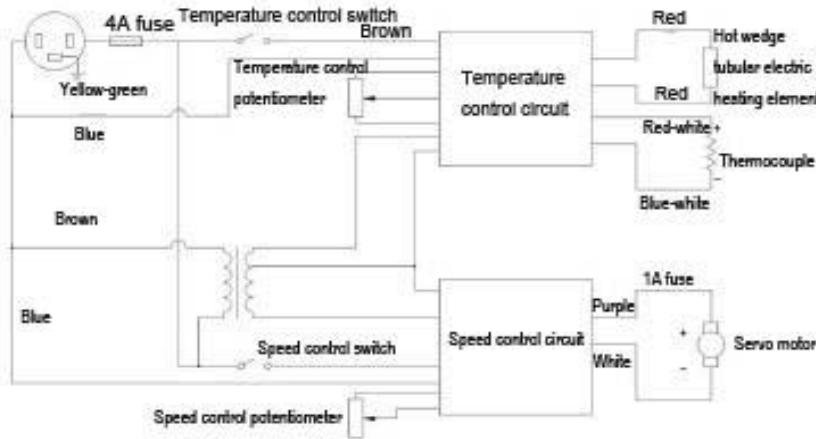

Fig.9 Control schematic diagram

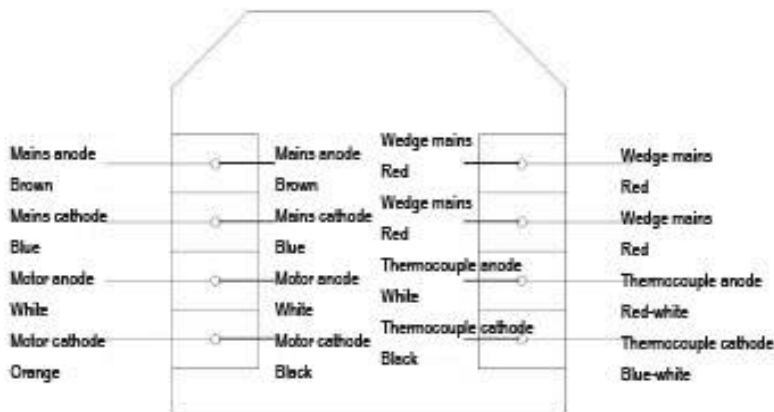

Fig.10 Control box wiring

Note: The colors of real wires may be not totally agreed with this figure. Perform as per real function on wiring.

## 8. General troubles and eliminations

Motor not run	Power off	Check that the mains is in <b>On</b> condition
	Fuse damaged	Replace fuse
	Speed control circuit board damaged	Replace speed control circuit board or control box assembly
	Motor burned	Replace motor
Motor speed can't be regulated	Speed control knob is loosened	Tighten speed control knob



	Power tube disruption	Replace power tube or control box assembly
Hot wedge do not heat	Tubular electric heating element damaged	Replace hot wedge assembly
	Thermocouple failure	Replace thermocouple
	Temperature control knob loosened	Tighten temperature control knob
	Temperature control circuit board damaged	Replace temperature control circuit board or control box assembly
Hot wedge is burned red	Thermocouple failure	Replace thermocouple
	Controlled silicon disruption	Replace controlled silicon or control box assembly
Chain jumping	There may be sand or small stones on chain and gear	Remove sand or small stones

## 9. Maintenance

The complete machine should be cleaned, greased and placed in a dry place if it is not used.

For PVC welding, the adhesions on hot wedge should be cleaned off if it is not used longer than 4 hours to prevent wedge corrosion and service life being shortened.

Recommend: for welding of material that corrosive gas may be produced after hot fusing such as PVC and the like, stainless steel hot wedge (optional accessory) is preferred for extending of service life.

## 10. Supplied accessories

Protector tube 4A 2 pcs

1A 2 pcs

Cross rubber pad for coupling 1 pcs

Philips driver 1 pcs

Inner hexagonal spanner 3 pcs

Silica gel wheel 1 pair